

**Mikro**<sup>®</sup>

v2.0

*Digital Power Meter*

*User Manual*

*DPM380 / DPM380B*



## HAZARD CATEGORIES AND SPECIAL SYMBOL

Read all instructions carefully and check the device before installation. The following safety alert symbol may appear throughout this manual or on device to warn any potential hazards or to call for attention.



### **PLEASE NOTE**

The power meter should be installed, operated, serviced and maintained only by qualified personnel. No responsibility is assumed by the manufacturer for any consequences arising out of the use of this material.

## BEFORE YOU BEGIN

- Apply appropriate personal protective equipment and follow safe electrical work practices.
- NEVER work alone.
- Turn-off all power supplying the power meter and the equipment in which it is installed before working on it.
- Always use a properly rated voltage sensing device to confirm that all power is off.
- Before closing all covers and doors, carefully inspect the work area for tools and objects that may have been left inside the equipment.
- NEVER bypass external fusing.
- NEVER open circuit a CT; use the shorting block to short circuit the leads of the CT before removing the connection from the power meter.
- Before performing hi-pot testing on any equipment in which the power meter is installed, disconnect all input and output wires to the power meter. High voltage testing may damage electronic components contained in the power meter.
- The power meter should be installed in a suitable electrical enclosure.

**Failure to follow this instruction may result in serious injury.**

# CONTENTS

<b>1. Parts of Power Meter</b>	<b>1</b>
<b>2. Installation Guide</b>	<b>3</b>
2.1. Mounting	3
2.2. Wiring	4
<b>3. Display and Buttons</b>	<b>8</b>
<b>4. Function</b>	<b>9</b>
<b>5. Setting up</b>	<b>11</b>
5.1. Access programming mode	11
5.2. Setup CT ratio	12
5.3. Setup PT ratio	13
5.4. Neutral current	14
5.5. Scroll mode	16
5.6. Reset all energy register	17
5.7. Reset on hour	18
5.8. Setup communication configuration	19
5.9. Remote set	20
5.10. LCD Backlight setting	21
5.11. System configuration	22
5.12. Clear full energy sign	23

5.13. Exit from programming mode	24
5.14. Setup the password	25
<b>6. Specifications</b>	<b>27</b>
<b>7. Modbus table</b>	<b>30</b>
<b>8. Maintenance and troubleshooting</b>	<b>36</b>
<b>9. Meter dimensions</b>	<b>37</b>

## FIGURES

1.	<b>Parts of the power meter</b>	<b>1</b>
2.	<b>Panel cut-out</b>	<b>3</b>
3.	<b>3-phase 4-wire system with 4 CTs</b>	<b>4</b>
4.	<b>3-phase 4-wire system with 3 CTs</b>	<b>5</b>
5.	<b>3-phase 3-wire with 3CTs and 3VTs</b>	<b>6</b>
6.	<b>3-phase 3-wire with 2CTs and 3VTs</b>	<b>7</b>
7.	<b>Menu map for the normal mode</b>	<b>9</b>
8.	<b>Flow map for the programming mode</b>	<b>10</b>
9.	<b>Automatic display scrolling</b>	<b>16</b>

# 1. Parts of the Power Meter

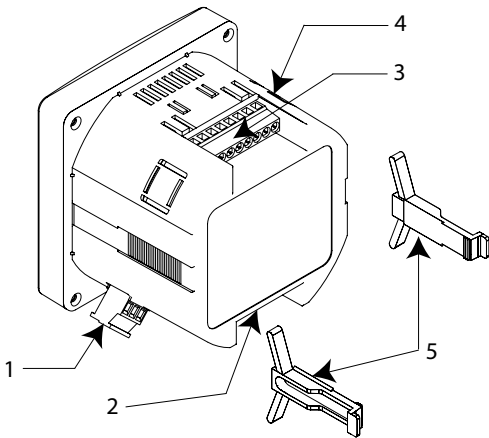

Figure 1: Parts of the power meter

Table 1: Meter Parts

<b>Number</b>	<b>Part</b>	<b>Description</b>
1	Auxiliary power supply input	Meter auxiliary power supply
2	Voltage input	Metering voltage connection.
3	Current input	Metering current connection.
4	RS485 port	RS485 connection for Modbus-RTU
5	Retainer clip	Clip to hold meter in cut-out hole

<b>Model Information</b>	
DPM380-415AD	Auxiliary 90~415VAC or 100~300VDC; with RS485
DPM380B-415AD	Auxiliary 90~415VAC or 100~300VDC; without RS485



## 2. Installation Guide

### 2.1. MOUNTING

a) Insert the power meter through a 91mmx91mm or 101.6mm radius hole as shown in figure 2 below:

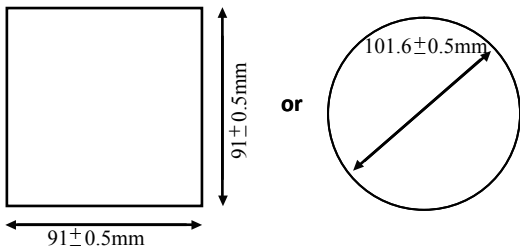

Figure 2: Recommended panel cut-out.

b) Slide the retainer clip along the slots on both sides of the power meter until the device is tightly secured on the switch-gear panel. The retainer clip can be removed by lifting the tab lightly at the handle end.

## 2.2. WIRING



Polarity marks must be followed as shown for CTs (S1 and S2).

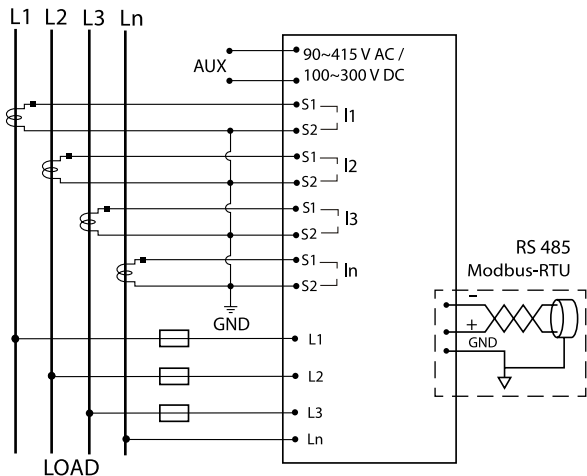

Figure 3: 3-phase 4-wire system with 4CTs connection, direct voltage input.

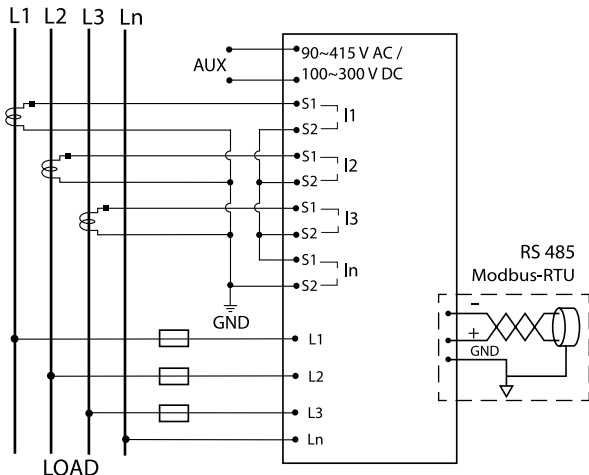

Figure 4: 3-phase 4-wire System with 3CTs connection, direct voltage input.

**NOTE:** Neutral current measurement is based on the vector sum of 3 CTs.

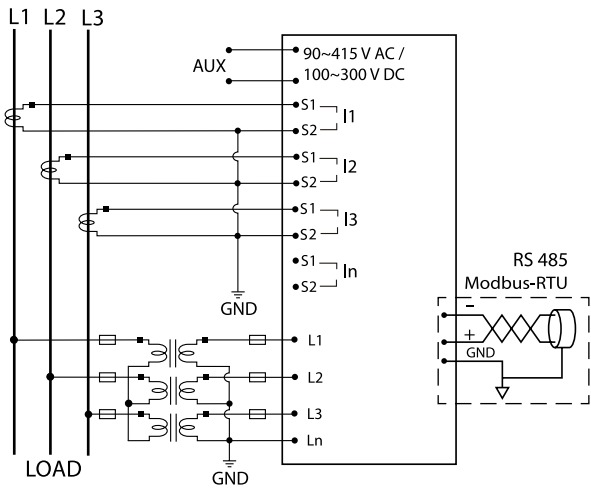

Figure 5: 3-phase 3-wire with 3CTs and 3VTs connection.

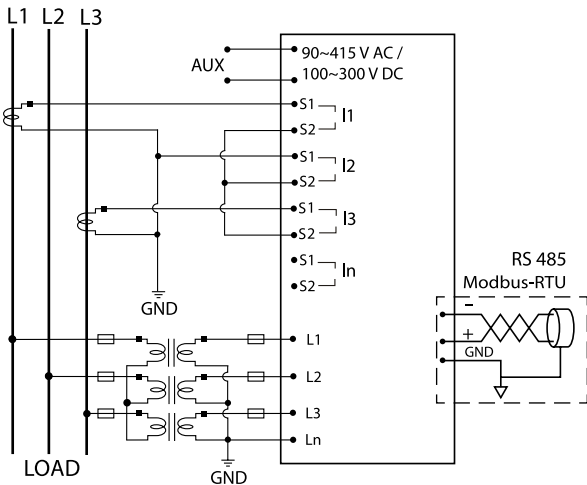
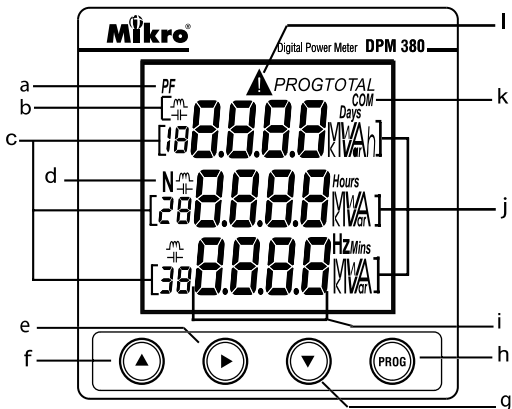

Figure 6: 3-phase 3-wire with 2CTs and 3VTs connection.

### 3. Display and Buttons



- |                                   |                            |
|-----------------------------------|----------------------------|
| a. Power Factor Indicator         | g. 'DOWN' button           |
| b. Capacitive/Inductive Indicator | h. 'PROG' button           |
| c. Phase Indicator                | i. 4-digit display         |
| d. Neutral Line Indicator         | j. Unit Indicator          |
| e. 'NEXT' button                  | k. RS485 Setting Indicator |
| f. 'UP' button                    | l. Warning Sign Indicator  |

## 4. Function

Figure 7 below shows menu map for the power meter. It includes the setting and measurement display for the power meter. These menus can be accessed by pressing NEXT, UP, PROG & DOWN buttons.

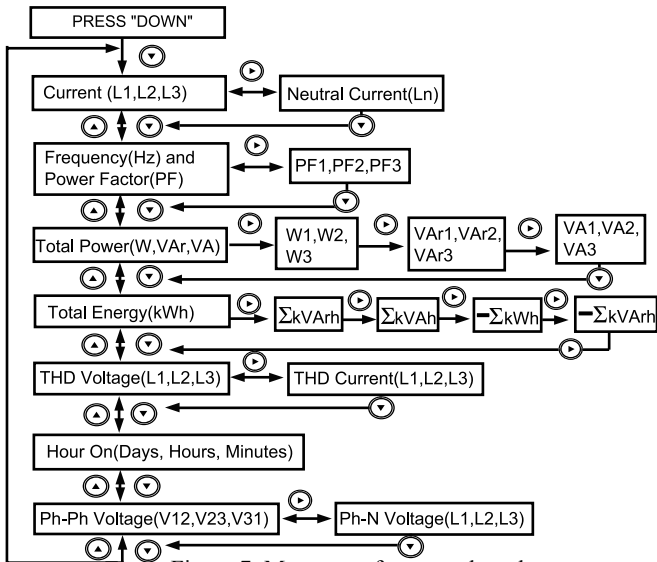
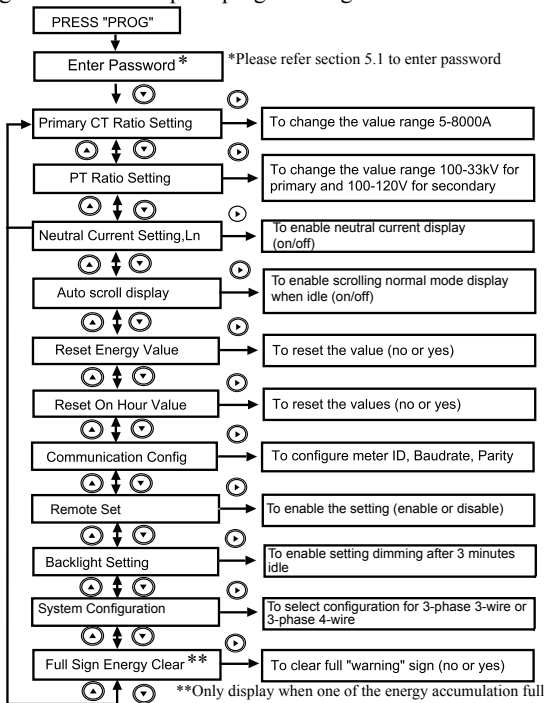

Figure 7: Menu map for normal mode.

Figure 8 : Menu map for programming mode









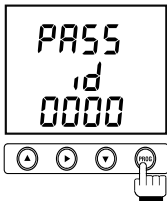

## 5. Setting up

This section explains how to set up the power meter.







### 5.1. ACCESS PROGRAMMING MODE

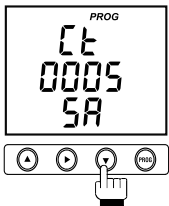

- Press the  button to enter programming mode. The user will be prompted to key in the password.
- Use the  or  button to change the value and the  button to shift to next number. The default password is “0000”.
- Press the  button to confirm and enter programming mode. Setup CT ratio display will appear with the “PROG” symbol. If the password is incorrect, the meter will return to normal mode.
- To exit without setting, press the  button and display will return to normal mode.









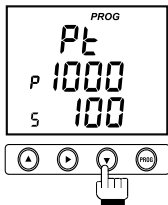

## 5.2. SETUP CT RATIO



- CT ratio setting is the first item display in programming mode.
- Press the  button to change. The “PROG” symbol will blink.
- Use the  or  button to change the primary CT value.
- Press the  button to temporarily confirm the new setting.
- To proceed to the next setting, press the  button.
- To exit programming mode, press the  button. The user will be prompted to confirm the saving of settings if change is made. Refer section 5.13.

## 5.3. SETUP PT RATIO



- Scroll in programming mode until "Pt" is displayed using the  or the  button.
- Press the  button. The "PROG" and "P" symbol will blink.
- Use the  or  button to change the primary PT value.
- Press the  button and the "S" symbol will blink to change setting secondary PT ratio.
- Use the  or  button to change the secondary PT value.
- Press the  button to temporarily confirm the new setting.
- To proceed to the next setting, press the  button.
- To exit programming mode, press the  button. The user will be prompted to confirm the saving of settings if change is made. Refer section 5.13.

**NOTE:** For direct voltage input, secondary PT set to "noPt".

## 5.4. NEUTRAL CURRENT

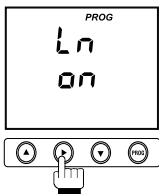

- a. Scroll in programming mode until “Ln” is displayed using the ◀ or ▶ button.
- b. This parameter allows the user to display neutral current if the neutral current input (In) is connected.
- c. Press the ▶ button to change. The “PROG” symbol will blink.
- d. Press the ◀ or ▼ button to toggle the symbol “on” for enable or “off” for disable.
- e. Press the ▶ button to temporarily confirm the new setting.
- f. To proceed to the next setting, press the ▼ button.
- g. To exit programming mode, press the ◻ button. The user will be prompted to confirm the saving of settings if change is made. Refer section 5.13.

**NOTE:** Neutral current measurement will be disabled when the system configuration is set to “3P3W”.

## 5.5. SCROLL MODE

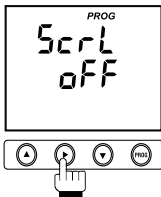

- a. In programming mode, scroll until the “SCrL” symbol is displayed using the ◀ or ▶ button.
- b. This function enables automatic display scrolling at every 10 second interval time.
- c. Press the ▶ button. The “PROG” symbol will blink.
- d. Use the ▶ or ◀ button to select the “on” or “oFF” symbols.
- e. Press the ▶ button to temporarily confirm the new setting.
- f. To proceed to the next setting, press the ▶ button.
- g. To exit programming mode, press the PROG button. The user will be prompted to confirm the saving of settings if change is made. Refer section 5.13.

**NOTE:** The scroll mode display flow as shown in figure 9.

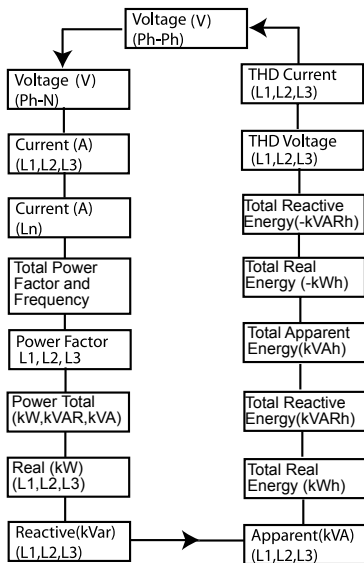
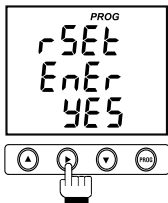

Figure 9: Automatic display scrolling

## 5.6. RESET ALL ENERGY REGISTER



- a. Scroll in programming mode until “rSET EnEr” is displayed using the or the .
- b. This function is to clear all energy register.
- c. Press the button. The “PROG” symbol will blink. Use the or button to toggle “YES” or “NO” symbols.
- d. To abort clearing energy register values, select “NO”.
- e. To clear all energy register values, select “YES”.
- f. Press the button to temporarily confirm.
- g. To proceed to the next setting, press the button.
- h. To exit programming mode, press the button. The user will be prompted to confirm the saving of settings if change is made. Refer section 5.13.

## 5.7. RESET ON HOUR

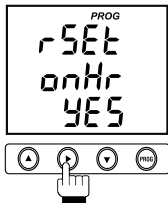

- a. Scroll in programming mode until “rSEt onHr” is displayed using the or the button.
- b. This function is to clear on hour register.
- c. Press the button. The “PROG” symbol will blink. Use the or button to toggle “YES” or “NO” symbols.
- d. To abort clearing on hour register, select “NO”.
- e. To clear on hour register, select “YES”.
- f. Press the button to temporarily confirm.
- g. To proceed to the next setting, press the button.
- h. To exit programming mode, press the button. The user will be prompted to confirm the saving of settings if change is made. Refer section 5.13.



## 5.8. SETUP COMMUNICATION CONFIGURATIONS

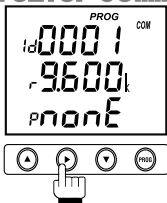

- Scroll using the or button until the “COM” symbol is displayed.
- Press the button. The “PROG” and “id” symbols will blink. Press the or button to change the device ID.
- Next, press the button and the “r” and “PROG” symbols will blink. Use the or button to select the baudrates.
- Next, press the button and the “P” and “PROG” symbols will blink. Use the or button to select the parity bit.
- Press the button to temporarily confirm the new setting.
- To proceed to the next setting, press the button.
- To exit programming mode, press the button. The user will be prompted to confirm the saving of settings if change is made. Refer section 5.13.

**NOTE:** Default value for the communication ID is 0001, baudrate is 38400 bps and parity set to none.

## 5.9. REMOTE SET

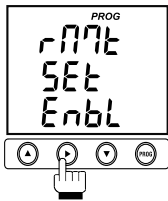

- Scroll in programming mode until “rMt SEt” is displayed using the ◀ or the ▶ button.
- Press the ▶ button. The “PROG” symbol will blink.
- To change, press the ◀ or ▼ button.
- To enable remote set, select “EnbL”.
- To disable remote set, select “dSbL”.
- Press the ▶ button to temporarily confirm the new setting.
- To proceed to the next setting, press the ▼ button.
- To exit programming mode, press the PROG button. The user will be prompted to confirm the saving of settings if change is made. Refer section 5.13.

**NOTE:** Enabling the remote set allows the remote terminal to read and write the meter setting via Modbus-RTU, otherwise the setting data can only be read.



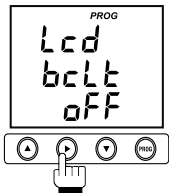



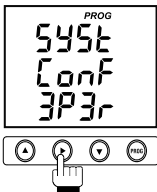

## 5.10. LCD BACKLIGHT SETTING



- a. Scroll in programming mode until “lcd bcLt” is displayed using the or the .
- b. This setting allows user to turn on the backlight permanently or turn off backlight automatically after 5 minutes idle.
- c. Press the button. The “PROG” symbol will blink.
- d. Use the or button to toggle symbols “on” or “oFF”.
- e. Select “on” for permanently on or “oFF” for automatically off.
- f. Press the button to temporarily confirm the new setting.
- g. To proceed to the next setting, press the button.
- h. To exit programming mode, press the button. The user will be prompted to confirm the saving of settings if change is made. Refer section 5.13.

## 5.11. SYSTEM CONFIGURATION



- Scroll in programming mode until “SYSt ConF” is displayed using the  or the .
- This setting allows user to set the meter configuration.
- Press the  button. The “PROG” symbol will blink.
- Use the  or  button to toggle symbols “3P3r” for 3phase 3-wire or “3P4r” for 3-phase 4-wire.
- Press the  button to temporarily confirm the new setting.
- To proceed to the next setting, press the .
- To exit programming mode, press the  button. The user will be prompted to confirm the saving of settings if change is made. Refer section 5.13.

## 5.12. CLEAR FULL ENERGY SIGN

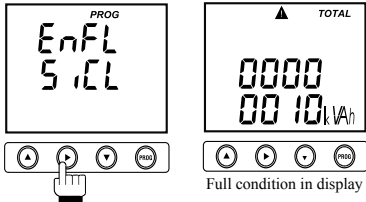



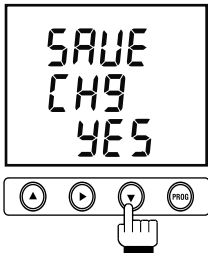

- Scroll in programming mode until “EnFL SiCL” is displayed using the or the .
- This function is to allow the user to clear the full () symbol. This will happen when an energy display reaches the maximum limit, 999999.99 Mega unit.
- Press the button. The “PROG” symbol will blink.
- Use the or button to change symbol “YES” or “NO”.
- To abort clearing full energy sign, select “NO”.
- To clear all full energy sign, select “YES”.
- Press the button to temporarily confirm.
- To proceed to the next setting, press the button.
- To exit programming mode, press the button. The user will be prompted to confirm the saving of settings if change is made. Refer section 5.13.

**NOTE:** This is only displayed when either one of the energy reaches the maximum limit.



## 5.13. EXIT FROM PROGRAMMING MODE





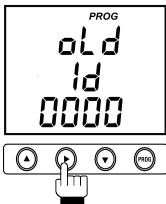

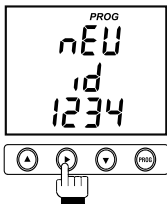

- Use the  button to exit from programming mode window. The “SAVE CHG” display will appear.
- Use the  or  button to select “YES” or “NO” symbols.
- To exit without saving the modified value, select “NO”.
- To exit and save the modified value, select “YES”.
- To confirm, press the  button. Meter will exit from programming mode.

## 5.14. SETUP THE PASSWORD





- a. Press the  and  buttons simultaneously until the password ID request window is displayed. Key in the current password. Refer to section 5.1 on how to do this.

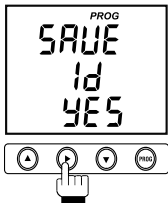

- b. After pressing the  button, the “new id” window will be displayed. At this stage, the user needs to key in the new password. Use the  or  button to change the digit value and the  button to shift to next digit. Once confirmed, press the  button.



- c. Next, the new password will be displayed. Use the  or  buttons to toggle the “YES” and “NO” symbols. Once confirmed, press the  button and the meter will return to normal display mode.



## 6. Specification

Electrical Characteristic	
System	3P3W & 3P4W
Current	
Display	Three phase current & neutral(selectable)
CT Primary	5-8000A
CT Secondary	5A
Accuracy	0.5% (from 1A to 6A secondary)
Sustained overload	6A
Voltage measurement	
PT Primary	100-33kV
PT Secondary	100,105,110,115,120, noPT
Secondary Phase Voltage	20~300VAC
Accuracy	0.5%
Power (kW,kVAR,kVA) measurement	
Display	each phase & total
Accuracy	1%

Power factor measurement	
Display	each phase & total
Accuracy	1%
Frequency measurement	
Range	45~65Hz
Accuracy	0.5%
Energy measurement	
Active	IEC62053-21:Class 1
Reactive	IEC62053-23:Class 2
Communication	
Hardware Interface	Isolated RS485
Protocol	Modbus-RTU
ID	1 to 127
Baudrate	2400, 4800, 9600, 19200, 38400
Parity	None, even, odd

<b>Operating Condition</b>	
Auxiliary Supply	90~415VAC or 100~300VDC
Operating Temperature	-10°C ~ +55°C
Storage Temperature	-20°C ~ +70°C
Operating time (on hour)	Up to 9999 days, 23 hours, 59 minutes.
<b>Mechanical Characteristic</b>	
<b>Dimension</b>	
Case	L96mm x W96mm x H83mm
Mounting type	Panel
LCD view area	55mmx48mm
Weight	400g
<b>Electromagnetic Compatibility (EMC)</b>	
Part 6-2: Generic Standards IEC61000-6-2	Immunity for industrial environments
Part 6-4: Generic Standards IEC61000-6-4	Emission standard for industrial environments

## 7. Modbus Table

Read Only (Function 0x03 or 0x04)				
Register	Description	Unit	Range	Type
4000-4001	Negative real energy	1kWh	0-999999.99M	Unsigned integer
4002-4003	Positive real energy	1kWh	0-999999.99M	Unsigned integer
4004-4005	reserved,always return 0			
4006-4007	Apparent energy	1kVAh	0-999999.99M	Unsigned integer
4008-4009	Negative reactive energy	1kVArh	0-999999.99M	Unsigned integer
4010-4011	Positive reactive energy	1kVArh	0-999999.99M	Unsigned integer
4012-4013	Total real power	1W	-2000M to 2000M	Signed integer
4014-4015	Total apparent power	1VA	0 to 2000M	Unsigned integer
4016-4017	Total reactive power	1VAR	-2000M to 2000M	Signed integer

Read Only (Function 0x03 or 0x04)				
Register	Description	Unit	Range	Type
4018	Total power factor	0.001	0 to 1.000	Unsigned integer
4019	Frequency	0.01Hz	45 to 65	Unsigned integer
4020-4021	Instantaneous Current L1	0.001A	0.005 to 15 (secondary)	Unsigned integer
4022-4023	Instantaneous Current L2	0.001A	0.005 to 15 (secondary)	Unsigned integer
4024-4025	Instantaneous Current L3	0.001A	0.005 to 15 (secondary)	Unsigned integer
4026-4027	Instantaneous Current Ln	0.001A	0.010 to 15 (secondary)	Unsigned integer
4028-4029	Voltage Phase L12	0.1V	20.0 to 520 (secondary)	Unsigned integer
4030-4031	Voltage Phase L23	0.1V	20.0 to 520 (secondary)	Unsigned integer
4032-4033	Voltage Phase L31	0.1V	20.0 to 520 (secondary)	Unsigned integer

Read Only (Function 0x03 or 0x04)				
Register	Description	Unit	Range	Type
4034-4035	Voltage Phase L1	0.1V	10.0 to 300 (secondary)	Unsigned integer
4036-4037	Voltage Phase L2	0.1V	10.0 to 300 (secondary)	Unsigned integer
4038-4039	Voltage Phase L3	0.1V	10.0 to 300 (secondary)	Unsigned integer
4040-4041	Real Power L1	1W	-2000M to 2000M	Signed integer
4042-4043	Real Power L2	1W	-2000M to 2000M	Signed integer
4044-4045	Real Power L3	1W	-2000M to 2000M	Signed integer
4046-4047	Apparent Power L1	1VA	0 to 2000M	Unsigned integer
4048-4049	Apparent Power L2	1VA	0 to 2000M	Unsigned integer
4050-4051	Apparent Power L3	1VA	0 to 2000M	Unsigned integer

Read Only (Function 0x03 or 0x04)				
Register	Description	Unit	Range	Type
4052-4053	Reactive Power L1	1VAR	-2000M to 2000M	Signed integer
4054-4055	Reactive Power L2	1VAR	-2000M to 2000M	Signed integer
4056-4057	Reactive Power L3	1VAR	-2000M to 2000M	Signed integer
4058-4081	reserved,always return 0			
4082	THD Current L1	0.1%	0 to 1000	Unsigned integer
4083	THD Current L2	0.1%	0 to 1000	Unsigned integer
4084	THD Current L3	0.1%	0 to 1000	Unsigned integer
4085	THD Voltage L1	0.1%	0 to 1000	Unsigned integer
4086	THD Voltage L2	0.1%	0 to 1000	Unsigned integer
4087	THD Voltage L3	0.1%	0 to 1000	Unsigned integer

Read Only (Function 0x03 or 0x04)		
Register	Description	Unit
4088	*Energy full flag bit 7 to 5 = reserved bit 4 = negative kVARh bit 3 = negative kWh bit 2 = kVAh bit 1 = positive kVARh bit 0 = positive kWh	
1000	device ID	1-127
1001	Parity	1=none 2=even 3=odd
1002	Baudrate	1=2400 2=4800 3=9600 4=19200 5=38400
0-1	reserved	
2-3	DeviceType	'301'
4-5	Version	'201'

\*if the energy is full, the bit is set to 1, else bit is 0.



Read or write (Function 0x03,0x04 or 0x06)		
Register	Description	Range
100	PT ratio primary	100-33kV
101	PT ratio secondary	100-120V
102	CT ratio primary	5-8000A
103-108	reserved,always return 0	
109	System scroll	0 or 1
110	Neutral setting	0 or 1
111	Minutes	0-59
112	Hours	0-23
113	Days	0-9999

**NOTE:** Register list is based on firmware version 2.0

## **8. *Maintenance and Troubleshooting***

The power meter does not contain any user-serviceable parts. If the power meter requires service, please contact your local sales representative. Do not open the power meter. Opening the power meter voids the warranty.

**NOTE:**

We reserve the right to alter or modify the information contained herein at any time in line with our product development without prior notification. We also reserve the right to discontinue production & delivery of product.

## 9. Meter Dimension

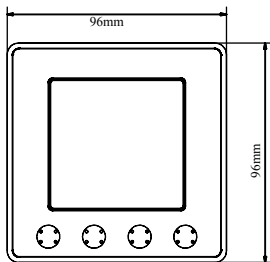

Front

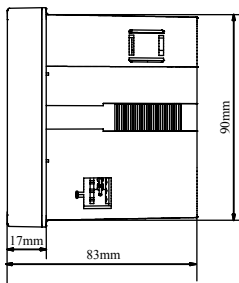

Side

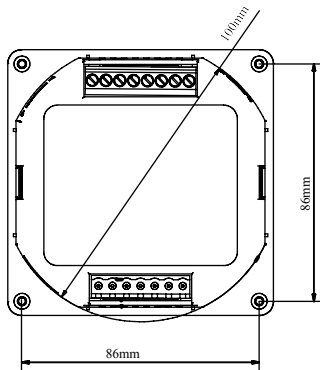

Rear